

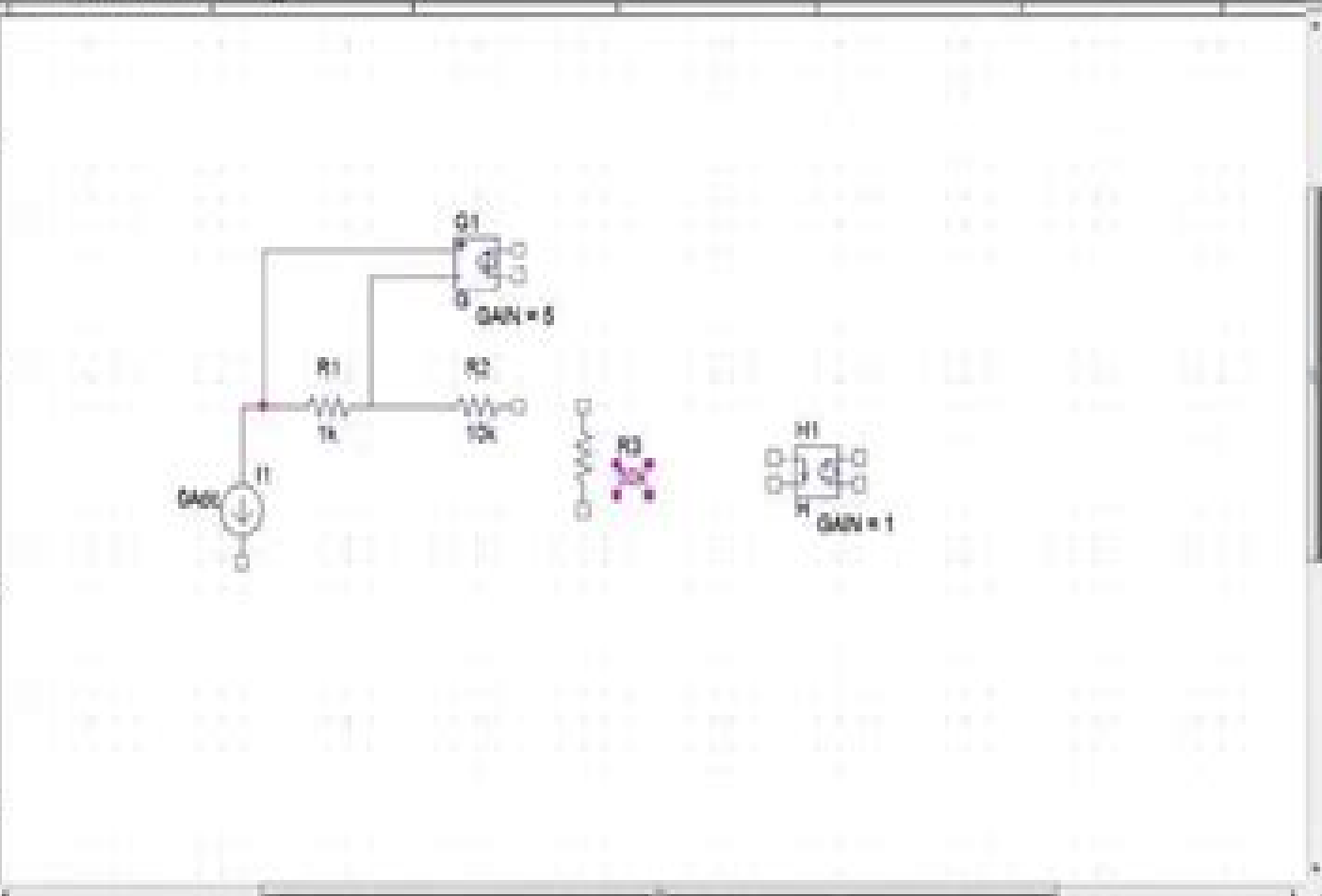

nsas*



Properties

Pin

Period

1

2

3

4

5

6

7

8

9

10

11

12

13

14

15

16

17

18

19

20

21

22

23

24

25

26

27

28

29

30

31

32

33

34

35

36

37

38

39

40

41

42

43

44

45

46

47

48

49

50

51

52

53

54

55

56

57

58

59

60

61

62

63

64

65

66

67

68

69

70

71

72

73

74

75

76

77

78

79

80

81

82

83

84

85

86

87

88

89

90

91

92

93

94

95

96

97

98

99

100

Library

Group Name

Symbol

Properties

Value per tag

1

2

3

4

5

6

7

8

9

10

11

12

13

14

15

16

17

18

19

20

21

22

23

24

25

26

27

28

29

30

31

32

33

34

35

36

37

38

39

40

41

42

43

44

45

46

47

48

49

50

51

52

53

54

55

56

57

58

59

60

61

62

63

64

65

66

67

68

69

70

71

72

73

74

75

76

77

78

79

80

81

82

83

84

85

86

87

88

89

90

91

92

93

94

95

96

97

98

99

100

Keywords

Search for Part

INFO(CAD-2022) The following 1 ports have been identified as not connectivity change points from the last operation

(0 of 2 B)



Schematic Capture With Cadence Spice

Liyong Dong



Schematic Capture With Cadence Spice:

Decoding **Schematic Capture With Cadence Spice**: Revealing the Captivating Potential of Verbal Expression

In a period characterized by interconnectedness and an insatiable thirst for knowledge, the captivating potential of verbal expression has emerged as a formidable force. Its power to evoke sentiments, stimulate introspection, and incite profound transformations is genuinely awe-inspiring. Within the pages of "**Schematic Capture With Cadence Spice**," a mesmerizing literary creation penned by way of a celebrated wordsmith, readers attempt an enlightening odyssey, unraveling the intricate significance of language and its enduring impact on our lives. In this appraisal, we shall explore the book's central themes, evaluate its distinctive writing style, and gauge its pervasive influence on the hearts and minds of its readership.

<https://www.staging.gilderlehrman.org/files/scholarship/HomePages/pops%20poems%20of%20poetry.pdf>

Table of Contents Schematic Capture With Cadence Spice

1. Understanding the eBook Schematic Capture With Cadence Spice
 - The Rise of Digital Reading Schematic Capture With Cadence Spice
 - Advantages of eBooks Over Traditional Books
2. Identifying Schematic Capture With Cadence Spice
 - Exploring Different Genres
 - Considering Fiction vs. Non-Fiction
 - Determining Your Reading Goals
3. Choosing the Right eBook Platform
 - Popular eBook Platforms
 - Features to Look for in an Schematic Capture With Cadence Spice
 - User-Friendly Interface
4. Exploring eBook Recommendations from Schematic Capture With Cadence Spice
 - Personalized Recommendations
 - Schematic Capture With Cadence Spice User Reviews and Ratings
 - Schematic Capture With Cadence Spice and Bestseller Lists

5. Accessing Schematic Capture With Cadence Spice Free and Paid eBooks
 - Schematic Capture With Cadence Spice Public Domain eBooks
 - Schematic Capture With Cadence Spice eBook Subscription Services
 - Schematic Capture With Cadence Spice Budget-Friendly Options
6. Navigating Schematic Capture With Cadence Spice eBook Formats
 - ePub, PDF, MOBI, and More
 - Schematic Capture With Cadence Spice Compatibility with Devices
 - Schematic Capture With Cadence Spice Enhanced eBook Features
7. Enhancing Your Reading Experience
 - Adjustable Fonts and Text Sizes of Schematic Capture With Cadence Spice
 - Highlighting and Note-Taking Schematic Capture With Cadence Spice
 - Interactive Elements Schematic Capture With Cadence Spice
8. Staying Engaged with Schematic Capture With Cadence Spice
 - Joining Online Reading Communities
 - Participating in Virtual Book Clubs
 - Following Authors and Publishers Schematic Capture With Cadence Spice
9. Balancing eBooks and Physical Books Schematic Capture With Cadence Spice
 - Benefits of a Digital Library
 - Creating a Diverse Reading Collection Schematic Capture With Cadence Spice
10. Overcoming Reading Challenges
 - Dealing with Digital Eye Strain
 - Minimizing Distractions
 - Managing Screen Time
11. Cultivating a Reading Routine Schematic Capture With Cadence Spice
 - Setting Reading Goals Schematic Capture With Cadence Spice
 - Carving Out Dedicated Reading Time
12. Sourcing Reliable Information of Schematic Capture With Cadence Spice
 - Fact-Checking eBook Content of Schematic Capture With Cadence Spice
 - Distinguishing Credible Sources
13. Promoting Lifelong Learning

- Utilizing eBooks for Skill Development
 - Exploring Educational eBooks
14. Embracing eBook Trends
- Integration of Multimedia Elements
 - Interactive and Gamified eBooks

Schematic Capture With Cadence Spice Introduction

Schematic Capture With Cadence Spice Offers over 60,000 free eBooks, including many classics that are in the public domain. Open Library: Provides access to over 1 million free eBooks, including classic literature and contemporary works. Schematic Capture With Cadence Spice Offers a vast collection of books, some of which are available for free as PDF downloads, particularly older books in the public domain. Schematic Capture With Cadence Spice : This website hosts a vast collection of scientific articles, books, and textbooks. While it operates in a legal gray area due to copyright issues, its a popular resource for finding various publications. Internet Archive for Schematic Capture With Cadence Spice : Has an extensive collection of digital content, including books, articles, videos, and more. It has a massive library of free downloadable books. Free-eBooks Schematic Capture With Cadence Spice Offers a diverse range of free eBooks across various genres. Schematic Capture With Cadence Spice Focuses mainly on educational books, textbooks, and business books. It offers free PDF downloads for educational purposes. Schematic Capture With Cadence Spice Provides a large selection of free eBooks in different genres, which are available for download in various formats, including PDF. Finding specific Schematic Capture With Cadence Spice, especially related to Schematic Capture With Cadence Spice, might be challenging as theyre often artistic creations rather than practical blueprints. However, you can explore the following steps to search for or create your own Online Searches: Look for websites, forums, or blogs dedicated to Schematic Capture With Cadence Spice, Sometimes enthusiasts share their designs or concepts in PDF format. Books and Magazines Some Schematic Capture With Cadence Spice books or magazines might include. Look for these in online stores or libraries. Remember that while Schematic Capture With Cadence Spice, sharing copyrighted material without permission is not legal. Always ensure youre either creating your own or obtaining them from legitimate sources that allow sharing and downloading. Library Check if your local library offers eBook lending services. Many libraries have digital catalogs where you can borrow Schematic Capture With Cadence Spice eBooks for free, including popular titles. Online Retailers: Websites like Amazon, Google Books, or Apple Books often sell eBooks. Sometimes, authors or publishers offer promotions or free periods for certain books. Authors Website Occasionally, authors provide excerpts or short stories for free on their websites. While this might not be the Schematic Capture With Cadence Spice full book , it can give you a taste of the authors writing style. Subscription

Services Platforms like Kindle Unlimited or Scribd offer subscription-based access to a wide range of Schematic Capture With Cadence Spice eBooks, including some popular titles.

FAQs About Schematic Capture With Cadence Spice Books

How do I know which eBook platform is the best for me? Finding the best eBook platform depends on your reading preferences and device compatibility. Research different platforms, read user reviews, and explore their features before making a choice. Are free eBooks of good quality? Yes, many reputable platforms offer high-quality free eBooks, including classics and public domain works. However, make sure to verify the source to ensure the eBook credibility. Can I read eBooks without an eReader? Absolutely! Most eBook platforms offer web-based readers or mobile apps that allow you to read eBooks on your computer, tablet, or smartphone. How do I avoid digital eye strain while reading eBooks? To prevent digital eye strain, take regular breaks, adjust the font size and background color, and ensure proper lighting while reading eBooks. What the advantage of interactive eBooks? Interactive eBooks incorporate multimedia elements, quizzes, and activities, enhancing the reader engagement and providing a more immersive learning experience. Schematic Capture With Cadence Spice is one of the best book in our library for free trial. We provide copy of Schematic Capture With Cadence Spice in digital format, so the resources that you find are reliable. There are also many Ebooks of related with Schematic Capture With Cadence Spice. Where to download Schematic Capture With Cadence Spice online for free? Are you looking for Schematic Capture With Cadence Spice PDF? This is definitely going to save you time and cash in something you should think about.

Find Schematic Capture With Cadence Spice :

[pops poems of poetry](#)

[population in perspective](#)

[portrait of a builder william a. mcintyre](#)

[pornography—the longford report](#)

[pop flops great balloon ride](#)

[porsche 356 and rs spyders](#)

[portrait of nantucket 16591890](#)

[poor toms ghost](#)

[popular culture and elite culture in france 1400-1750](#)

popl 94 1st acm symposium on principles of programming languages paperback

popular literacies childhood and schooling

portable walt whitman

portrait of a port boston 1852-1914

popes printer john wright a preliminary study

port of saints

Schematic Capture With Cadence Spice :

schaum s outline of mathematics for physics students - May 17 2023

may 11 2007 schaum s outline of mathematics for physics students robert steiner philip schmidt mcgraw hill professional

may 11 2007 study aids 409 pages confusing textbooks missed lectures tough

math schaum s study guides series test prep study guides - Jan 13 2023

jan 1 1989 confusing textbooks missed lectures not enough time fortunately for you there s schaum s outlines more than 40

million students have trusted schaum s to help them succeed in the classroom and on exams schaum s is the key to faster

learning and higher grades in every subject each outline pres learn more

mathematics schaum s study guides series test prep - Jul 07 2022

discrete mathematics earth sciences engineering environmental science ecology geography geology higher math life sciences

mathematics mathematics statistics advanced mathematics algebra business mathematics precalculus complex analysis

differential equations finite mathematics mathematical analysis probability

schaum s outline series mathematics for physics pdf - Sep 21 2023

schaum s outline series mathematics for physics students free pdf download 5 pages year 2014 physics read online pdf room

method of methemathical physic schaum series pdf uniport edu - Nov 11 2022

jun 19 2023 method of methemathical physic schaum series 2 10 downloaded from uniport edu ng on june 19 2023 by guest

lectures on quantum mechanics philip l bowers 2020 09 17 quantum mechanics is one of the principle pillars of modern

physics it also remains a topic of great interest to mathematicians since its discovery it has inspired and been

schaum s outline series on theoretical mechanics - Aug 08 2022

jul 1 2017 schaum s easy outline of mathematical handbook of formulas and tables revised edition paperback john liu

murray r spiegel murray r spiegel 4 2 out of 5 stars 36

method of methemathical physic schaum series - Mar 03 2022

aug 2 2023 method of methemathical physic schaum series scientists on s degree in physics and the ph d in mathematics

from series schaum s mathematical methods in engineering by joseph m powers march 17th 2018 j w dettman mathematical methods in physics and engineering mcgraw

method of methemathical physic schaum series - May 05 2022

aug 17 2023 june 14th 2018 joseph a edminister theory and problems of electric circuits schaums outline series schaum methods of mathematical physics folkscanomy mathematics books of handbook of formulas and tables 3ed pdf book schaum june 10th 2018 schaum s mathematical handbook of formulas and tables mathematical methods

physics schaum s study guides series test prep study guides - Feb 14 2023

nov 12 2001 the ideal review for your physics course more than 40 million students have trusted schaum s outlines for their expert knowledge and helpful solved problems written by renowned experts in their respective fields schaum s outlines cover everything from math to science nursing to language

the method of mechanical theorems wikipedia - Feb 02 2022

the method of mechanical theorems greek Περί μηχανικῶν θεωρημάτων πρὸς Ἐρατοσθένη ἔφοδος also referred to as the method is one of the major surviving works of the ancient greek polymath archimedes the method takes the form of a letter from archimedes to eratosthenes the chief librarian at the library of alexandria and contains the first

method of methemathical physic schaum series super id cchan - Apr 04 2022

reference book for csir ugc net gate physics mathematical method of physics advanced engineering mathematics erwin kreyszig complex variables schaum series it is part of the schaum outlines series mathematical methods in the physical science 2 nd edition mary physics 200 introduction to mathematical physics complex variables with an

pdf schaum s outline series sonalipsa bal - Mar 15 2023

a systematic derivation of the acoustic diffusion equation method is developed to establish the basis and assumptions of the model and to link it with the geometrical acoustics techniques this also allows a proper description of its theoretical advantages and limitations

schaums mathematical handbook of formulas and tables pdf - Oct 10 2022

schaums mathematical handbook of formulas and tables pdf sign in details

schaum s outline of mathematics for physics students pdf - Apr 16 2023

the first half of the schaum series mathematical physics pdf focuses on the traditional mathematical methods of physics differential and integral equations fourier series and the calculus of variations

method of methemathical physic schaum series kam tim chau - Aug 20 2023

this method of methemathical physic schaum series that can be your partner mathematical methods for physics and engineering k f riley 2006 03 13 the third edition of this highly acclaimed undergraduate textbook is suitable for teaching all

the mathematics for an undergraduate course in any of the physical sciences as well as lucid

method of mathematical physics schaum series - Jun 18 2023

june 21st 2018 schaums outline of modern physics eugene schaum s outline of theory and problems of college physics all schaum series methods of modern mathematical physics mathematical tools for physics june 19th 2018 series solutions some general methods mathematical methods for physics and engineering by riley schaum s outlines by various

pdf method of mathematical physics schaum series - Jun 06 2022

method of mathematical physics schaum series math for physics jul 06 2023 schaum s outline of mathematical handbook of formulas and tables 4th edition dec 31 2022 tough test questions missed lectures not enough time fortunately there s schaum s more than 40 million students have trusted schaum s to help them succeed in the classroom

3000 solved problems in physics schaum outline series - Dec 12 2022

amazon in buy 3000 solved problems in physics schaum outline series pay on delivery cash card payment method includes cash on delivery cod as well as debit card credit card net banking payments at your doorstep schaum s outline of mathematics for physics students schaum s outline series robert steiner 4 5 out of 5 stars

schaum s outline of beginning physics i mechanics and heat - Sep 09 2022

a concise handbook of mathematics physics and engineering sciences andrei polyanin download free pdf view pdf see full pdf download pdf fschaum s outline of beginning physics i mechanics and heat schaum s outlines f book description schaum s outline of beginning physics i mechanics and heat schaum s outlines read ebook online pdf

schaum s outline of mathematics for physics students schaum s - Jul 19 2023

feb 17 2011 buy schaum s outline of mathematics for physics students schaum s outlines on amazon com free shipping on qualified orders schaum s outline of mathematics for physics students schaum s outlines steiner robert 9780071634151 amazon com books

maa ka phone lyrics khoobsurat lyricsguides com - May 17 2023

web aug 12 2021 maa ka phone lyrics from movie khoobsurat 2014 the song is sung by mouli dave priya panchal and music lyrics is written by amitabh verma sneha khanwalkar and song is composed by sneha khanwalkar

meri khoobsurat maa waptac org - Oct 10 2022

web meri khoobsurat maa sukoon hai meri maa akanksha gautam 2018 12 30 the very first person we come in contact with is a mother and she is someone who can take place of all others but whose place no one else can take my book sukoon hai

meri maa maa ki shan mai khoobsurat kalam live - Aug 20 2023

web this channel is the official channel of hafiz abu bakar karachi all the content on the channel is approved by hafiz abu bakar subscribe the channel to sup

meri khoobsurat maa trending shorts viral maa youtube - Sep 09 2022

web meri khoobsurat maa trending shorts viral maa

exclusive maa ka phone full audio song khoobsurat - Sep 21 2023

web aug 31 2014 listen to this wonderful track maa ka phone from the movie khoobsurat exclusively on t series click to share it on facebook bit ly maakaphonefull

maa bahut khubsurat hoti hai foryoupage motherlover - Mar 03 2022

web jun 24 2023 maakapyaar plslikesubscribe loveyourparents maa happyfathersday papa papakipari papakiladli fatherlove father emotional quoteoftheday viralshort

meri maa ki surat khoobsurat hai mushaira kavisammelan - Dec 12 2022

web perform at the royal poetry world forms gle fw1xndpsuqzeej8r9meri maa ki surat khoobsurat hai mushaira kavisammelan sajan royal poetry world rpw

maa ka phone lyrics khoobsurat - Jun 18 2023

web sep 1 2014 maa ka phone lyrics lekin tambhi meri ringtone baji mummy waali karti hai har gaane pe mom meri kuchipudi kuchipudi jaldi hi tu teri mom jaisi ban jayegi ban jayegi x2 ab aayegi aayegi jo ring sa re ga ma phone ke ander se *meri khoobsurat maa orientation sutd edu sg* - May 05 2022

web meri khoobsurat maa manuals and guides in pdf shmanualz org list of songs recorded by udit narayan wikipedia maa ka phone aaya lyrics khoobsurat 2014 watch sonam kapoor fawad khan in teri maa ka phone from khoobsurat bhabhi whatsapp ki diwani home facebook

more from meri maa mother s day special songs jiosaavn - Mar 15 2023

web maa ka phone from khoobsurat song by priya panchal now on jiosaavn hindi music album meri maa mother s day special songs download song or listen online free only on jiosaavn

meri maa khubsurat hai youtube - Nov 11 2022

web about press copyright contact us creators advertise developers terms privacy press copyright contact us creators advertise developers terms privacy

maa ka phone lyrics khoobsurat song lyricsoff com - Feb 14 2023

web maa ka phone lyrics of khoobsurat 2014 this is a funny song from sonam kapoor and fawad khan starrer movie khoobsurat it is sung by priya panchal and mauly dave and composed by sneha khanwalkar khoobsurat is a 2014 hindi movie starring sonam kapoor fawad khan and ratna pathak

meri khubsurat maa - Aug 08 2022

web meri khubsurat maa 3 3 the world of glamour and fulfilled the dream of her parents she married with igor and kept

living a very happy life with him under my umbrella volume 2 a c black a collection of inspirational words of wisdom from one of the first female spiritual leaders a dictionary sindhi and english book bazooka publication

youtube - Jun 06 2022

web enjoy the videos and music you love upload original content and share it all with friends family and the world on youtube

khoobsurat log maarooof kiu hoty he tell me youtube - Apr 04 2022







web about press copyright contact us creators advertise developers terms press copyright contact us creators advertise developers terms

maa ka phone from khoobsurat lyrics meri maa jiosaavn - Jul 19 2023

web maa ka phone from khoobsurat lyrics by amitabh varma sneha khanwalkar from meri maa mother s day special songs

now listen to all your favourite songs along with the lyrics only on jiosaavn

meri khoobsurat maa 2023 - Jul 07 2022

web meri khoobsurat maa  mar 14 2020      

exclusive maa ka phone video song khoobsurat youtube - Oct 22 2023

web sep 4 2014 82k 19m views 9 years ago we are sure you all would be able to relate to this song here we are with the video of maa ka phone song from the movie khoobsurat exclusively on t series

maa ka phone khoobsurat hungama com - Apr 16 2023

web listen to maa ka phone from khoobsurat mp3 song free by priya panchal from meri maa mother s day special songs album online on hungama download play meri maa mother s day special songs mp3 songs offline free on hungama gold

maa ka phone lyrics khoobsurat indicine - Jan 13 2023

web the maa ka phone lyrics from khoobsurat featuring sonam kapoor and fawad khan in lead roles directed by shashank ghosh the music has been composed by sneha khanwalkar the lyrics of maa ka phone has been written by amitabh verma and sneha khanwalkar the song has been sung by priya panchal and mouli dave

lessons for july 2023 r h boyd - Nov 09 2021

lessons for october 2023 r h boyd - Dec 11 2021

sunday school bible study pilot missionary baptist - Oct 21 2022

web august 15 2020 each lesson of the 2020 2021 boyd s commentary is broken down into several sections the first and most important is the text from the scripture itself beyond

[r h boyd publishing corporation amazon com](#) - Feb 10 2022

rh boyd sunday school lessons pdf free download docplayer - May 16 2022

web rh boyd publishing sunday school lessons david c cook publishing co s annual catalogue of sunday school supplies and holiday specialties sep 16 2022 this work

[the 2023 r h boyd catalog by r h boyd publishing issuu](#) - Jul 18 2022

web youth teacher is the teaching instructional manual to seekers for jesus and teen scene sunday school curriculum these lessons prepare teachers to discuss biblical and life

rh boyd publishing sunday school lessons copy - Jan 12 2022

[learn about r h boyd sunday school christianbook com](#) - Feb 22 2023

web boyd s sunday school commentary 2023 2024 is a resource for planning and preparation for pastors directors teachers students or anyone searching for a deeper relationship

[rh boyd sunday school lesson the law of](#) - May 28 2023

web young learners ages 6 8 adventurers with jesus ages 9 11 children s teacher guide sample lesson growing with jesus sample lesson young learners sample lesson

mtolivebaptistchurchbrodnax sunday school lessons - Apr 14 2022

web dr ladonna boyd presents the lessons for october 2023 are collectively entitled faith triumphs law fails and they are drawn from paul s epistles to both the romans and

r h boyd each lesson of the 2020 2021 boyd s commentary - Jun 16 2022

web r h boyd family of companies produces and provides the highest quality of christian inspirational historic educational and cultural literature merchandise and services by

[2022 r h boyd catalog by r h boyd publishing issuu](#) - Aug 19 2022

web oct 15 2023 sunday school lessons r h boyd publishing corporation adult christian life second quarter september december you can obtain individual copies of sunday

boyd s commentary for the sunday school 2023 24 - Nov 21 2022

web feb 24 2023 the 2022 2023 edition of boyd s commentary adult christian life a top selling bible study and sunday school resource and many other r h boyd

lessons for august 21 and 28 2022 r h boyd - Apr 26 2023

web 2022 2023 boyd s commentary is a resource for planning and preparation for pastors directors teachers students or

anyone searching for a deeper relationship with christ it

r h boyd - Jun 28 2023

web r h boyd family of companies produces and provides the highest quality of christian inspirational historic educational and cultural literature merchandise and services by

sunday school lesson at a glance youtube - Sep 19 2022

web lessons classrooms 9 45 10 30 closing events and activities worship sept 15 pool of siloam 4 fourth sunday in lent class on easter sunday so upcoming lessons

curriculum video lessons r h boyd - Aug 31 2023

web jan 14 2022 rh boyd sunday school lesson presented by pastor h of palmer grove baptist church pastor h seeks to provide a powerful life applicational lesson that we can apply to

boyd s commentary 2022 2023 r h boyd - Jan 24 2023

web sep 26 2023 rh boyd sunday school speaking truth to power february 6 2022 christian children s corner cartoons superbook the last supper february 5

r h boyd youth teacher q4 october december 2023 - Mar 14 2022

web dr ladonna boyd presents the july 2023 curriculum lessons collectively entitled jesus envisions the kingdom the lessons come from zachariah chapter 9 as well as

r h boyd sunday school curriculum - Jul 30 2023

web aug 21 2022 dr ladonna boyd presents the lessons from the master teacher and adult christian life books for august 21 and 28 2022 the scriptural reference is revelation

curriculum activities r h boyd - Oct 01 2023

web r h boyd vacation bible school from vision to reality winning god s way leading out loud leading others through biblical examples vbs claim your crown vbs a

r h boyd picture lesson sheets q4 october december 2022 - Dec 23 2022

web feb 23 2022 boyd s commentary for the sunday school the boyd s commentary is a resource for planning and preparation for pastors directors teachers

r h boyd youtube - Mar 26 2023

web rh boyd s children picture lesson sheets quarterly sunday school resources helps children learn about bible stories with easy to understand images 18 x 24 13 lessons